



Putzmeister



Truck-mounted concrete pump M42

Cost-friendly versatility on 4 axles

The new M42 pays off – construction site after construction site



Get more for less

The new M42 is an investment where you get everything you need. Everything which has been tried and tested over decades, which we have newly developed based on our experience and expertise and everything which you, your operators and your customers have expected from us. The result is not less than a completely new generation of concrete pumps.

A truck-mounted concrete pump must, first and foremost, prove itself in everyday use - every day, in every application. The M42 has an extremely high spectrum, which ranges from medium-sized to large

construction sites and also does not give up when faced with restricted set-up situations.

How is that possible? With excellent flexibility, which the 5-arm boom in a compact roll-Z-folding offers. With operation which leaves nothing to be desired thanks to the computer-based control with EPS, EOC and EBC (optional) including the comfortable radio remote control system. With a balanced load distribution on 4 axles, as well as our TRDI support, which always allows the vehicle to move legally in traffic or set-up safely at the place of use. Details on everything which we have forgotten to mention here can be found on the next few pages.

The Putzmeister promise

The name Putzmeister stands for machines that enable you to work with extreme productivity and go beyond purely being competitive. To this end, we provide extraordinarily innovative technologies alongside top quality and excellent service. We are fully dedicated to supporting you both around the world and around the clock. And this is because every Putzmeister employee recognises that your machine has important jobs to do.

Your Putzmeister Team

The placing boom – 42 m flexibility up to top of the boom

For (almost) all applications

M42, this is 42 m vertical reach distributed over 5 arms with compact design in roll Z-folding. 5 arms, this means a high degree of versatility in applications. For example, when reaching into buildings, the hinge of the fifth boom is crucial to reaching fully into the building interior. The optimised kinematics ensure that the workspace is maximised and there is no “dead space”.

The 5-arm placing boom in roll Z-folding is the successful combination of flexibility and compactness. With a very low unfolding height, optimum slip characteristics and optimal use of the net horizontal reach, you have almost unlimited application possibilities. The advantages of the roll and the Z-folding are thus combined in an extremely efficient way.

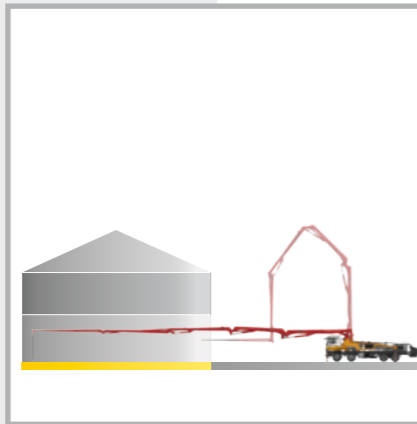
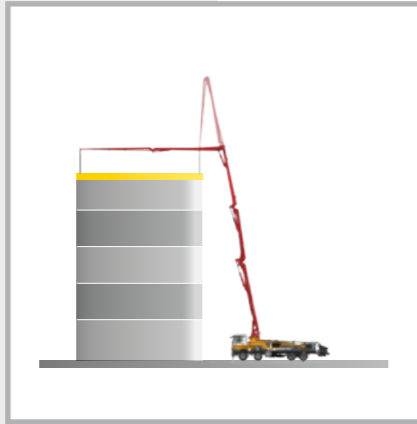

The new boom at a glance

- **Approx. 42 m vertical reach** with 5 arms in roll Z-folding
- **No dead space**, enhanced flexibility
- **Direct response characteristics** of boom control
- **Safety** thanks to reduced boom vibrations
- **EBC (optional)** for vibration damping, one-handed control, restriction of workspace
- **Standard delivery line bends of 90° and 45°** with extended collars on both sides **for longer service life**
- **Low unfolding height**

Top-class with standardisation

Your machines work efficiently when they are used at full capacity. This also includes versatile use and optimal availability. The costs for service and maintenance must be kept low. With this in mind, we have once again optimised the new series. Only components with a high wear resistance, as well as maintenance-free components where possible or many standard components, were installed. For example, we have reduced the bend types in the boom from 7 to 3 standard delivery line bend types. And standard screwed-in pipeline supports save time and money when aligning the delivery line. The good accessibility make service and repair work easier, quicker and more cost-effective.

Robust and maintenance-free components

- + **Combined auto lube system**
- + **High wear resistance**
- = **Maximum durability**

Precise, easy and safe to operate

The boom control's fast response characteristics, the sophisticated routing of the delivery lines and the robust steel structure ensure precise work. The boom only swings minimally, even at high outputs.

Even more comfort with EBC (Ergonic® Boom Control)

The fully electronic control system with integrated vibration damping enables the end hose to be guided continuously. The boom can be moved even more smoothly using the joystick in one-handed operation. Limiting the working area or locking arm positions increases occupational safety.

ergonic
inside



The substructure – firm base for massive performance



Efficient on 4 axles

The excellent torsion properties and enhanced flexibility in the substructure make a significant contribution to enhancing the driving comfort and service life of the machine. The M42 easily satisfies strict country-specific licensing regulations because its lightweight design allows additional loads for fuel and accessories. The wide platform with anti-slip surface offers sufficient space in this regard.

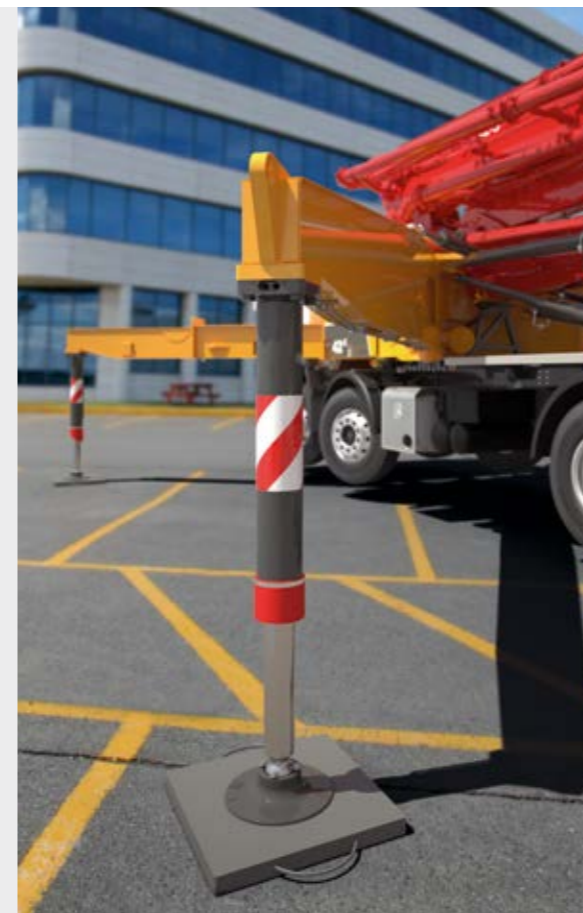

Less space – improved safety

More effort also means more costs. The tooling times should therefore be kept to a minimum. With the TRDI support developed by Putzmeister you save time and space, without compromising on safety.

Construction sites often only offer restricted set-up conditions, because they are located in urban areas or along busy roads. Double telescoping support legs can also be securely placed in minimal spaces between obstacles. And with the optional OSS* (One Side Support) and ESC (Ergonic® Setup Control)** the considerably small support width of under 8 m is further reduced.

An important side effect: Full use is made of the net horizontal reach for the fully supported side.

* OSS – assistance system for One Side Support, optional

** ESC – safety system for One Side Support (i.a.w. EN 12001:2012).

The new substructure at a glance

- Lightweight design offers high weight reserves
- I frame concept for improved torsion properties and longer service life
- Flexible, space-saving TRDI support system
- Significantly reduced support widths with use of OSS* and ESC** for restrictive setup conditions
- Less obstacles in the surrounding area, such as traffic for example



Concept for longer service life

Another benefit of TRDI lies in the force distribution. If the machine is supported correctly, then it stands freely on its legs. Forces are not distributed to the vehicle frame, but are distributed over the support legs. The vehicle is protected and the service life increased.

The new I frame and connection concept also ensures a longer service life in comparison to fixed frames. Maintenance-free components, the new comprehensive screw concept, as well as the consistent use of standard components, also play a role in reducing the operating and maintenance costs.

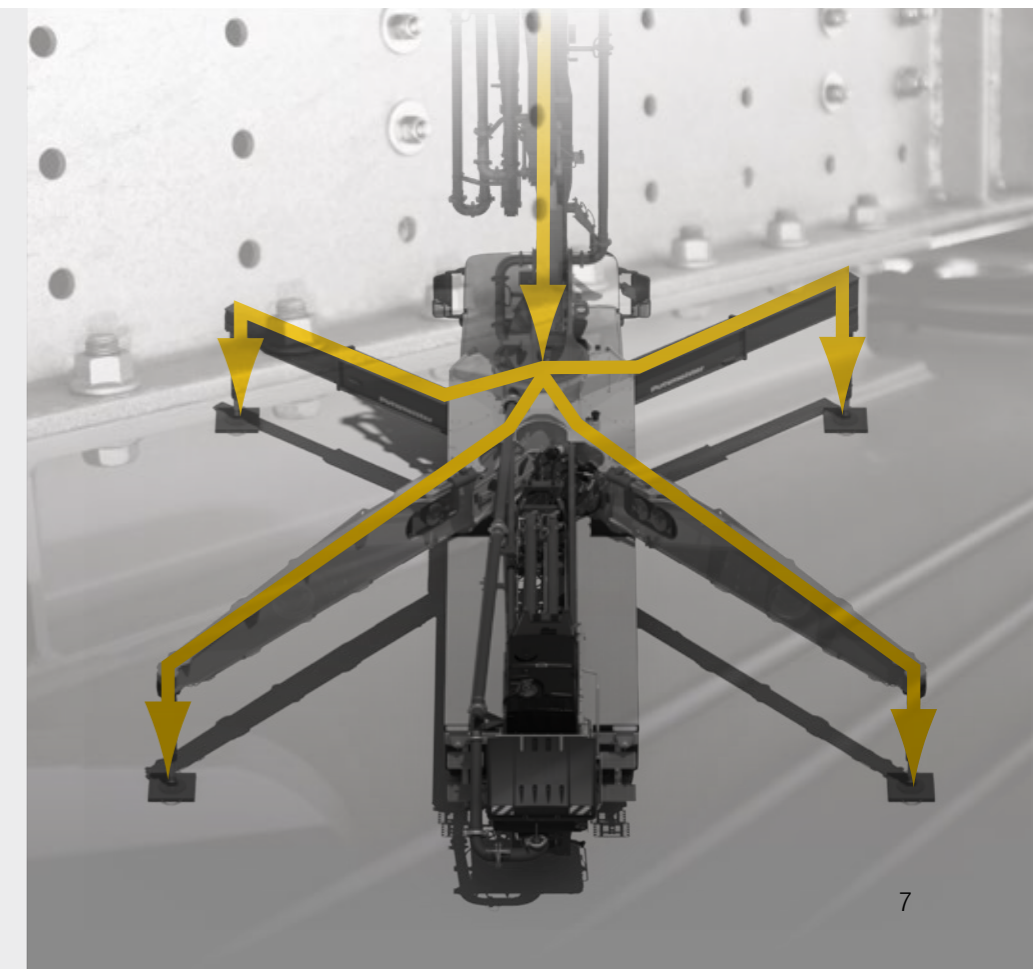

The concrete pump – clever interaction of all components

Strong unit for every type of concrete

Concrete pumps from Putzmeister are designed for all common types of concrete with their coordinated geometry. This is thanks to the closed free flow hydraulic circuit, among other things. The drive transfers more power and saves resources because the oil reaches the cylinder with minimal losses. In addition, the Ergonic® blue, the new Putzmeister concept for improved sustainability, integrates a new hydraulic fluid management system into the control system.

This new technology not only enables the necessary quantity of hydraulic fluid to be reduced by up to 50% – it also allows the use of environmentally friendly organic fluid. A further success factor is the S transfer tube point, which has a long service life even with wear-intensive materials. Because the S transfer tube was reinforced with build-up welding.



Optimal coordination thanks to EPS

The computer-aided control system of the pump ensures a better performance via EPS (Ergonic® Pump System). EPS controls the pumping process using computers, so that it is smoother overall and the boom vibrations are reduced. Besides EPS, EOC (Ergonic® Output Control) is an effective module to work efficiently. Because EOC controls the

engine speed with lower fuel consumption, wear and noise. Unfavourable areas are automatically avoided. The same applies to the SN control system and Push Over. They ensure that the concrete column is pushed very gently and wear-intensive pressure peaks are avoided.

The pump at a glance

- **Pump geometry is optimally** coordinated to all common types of concrete
- **Service-friendly control system** with free flow hydraulics and thus consistently high oil quality
- **Particularly wear-resistant** design of S transfer tube switch, which guarantees long service life
- **Optimised hopper** (screwed-in grille, improved shape and optimised S transfer tube storage)
- **Agitator safety shutdown via RFID** (Radio Frequency Identification), a detection system using electromagnetic waves, including start-up protection
- **Smooth, optimised pumping** with EPS and EOC, protects the pump and the vehicle
- **Optimised switchover procedure** with SN control system and Push Over avoids wear-intensive pressure peaks
- **Convenient and simple operation with Ergonic® 2.0**, the latest concept for control hardware and software from Putzmeister
- **Minimum operating costs** thanks to maintenance-free components, avoidance of special components and good accessibility
- **Easy replacement of components** due to screw concept, e.g. support cylinder
- **Automatic agitator direction of rotation corresponds to pumping direction**



You choose the power

Like all Putzmeister truck-mounted concrete pumps, the M42 is available with different pumps with a delivery pressure of 85 bar: The 16H with two chromium-plated delivery cylinders (dia. 230 mm), which is cheaper in comparison, and the smoother 16HLS resp. 17iLS (dia. 250 mm). They both offer a delivery rate of 160 m³/h resp. 170 m³/h, but the LS version has a lower number of strokes and is thus subjected to less wear.

Pumps

Model	Output m³/h	Pressure bar	Stroke mm	Cylinder Ø mm	Strokes/min
16 H	160*	85	2 100	230	31
16 H LS	160*	85	2 100	250	26
17 i LS	170*	85	2 100	250	27

All data represent theoretical maximum values.

* Rod/piston side. Max. delivery rates and max. delivery pressures cannot be operated at the same time.

The enhanced 17iLS also offers numerous benefits and improvements:

- **Fuel saving of up to 25 % with EOC 2.0** (field tested with multiple pumps for international applications)
- **More efficient pumping:** Oil leaks prevented by improved sealing system
- **Better pump start-up behaviour**
- **Longer service life** thanks to robust S-tube bearing



Ergonic® 2.0 – designed by operators for operators

Switching centre for maximum efficiency

If our concrete pumps form the heart of our machines, then Ergonic® 2.0 system is the head. As a switching centre, the microprocessor-supported control systems regulate the functions of concrete pumps, truck mixers and PUMI®. Increased efficiency, reduced costs and greater flexibility – these are the results of Putzmeister machines with Ergonic® 2.0 overcoming the difficulties of day-to-day work on the job site.



ergonic
inside



The new radio remote control – work 2.0

The extremely robust radio remote control is considerably lighter in the hand, owing not only to its reduced weight, but also the well thought-out ergonomic design. All displays can be optimally read on the larger, high-resolution colour screen. A Li-ion battery with a longer life and minimal self-discharge supplies the remote control with energy for an entire working day. Alternatively the remote control can be operated using a cable and supplied with current. With Ergonic® 2.0, specific machine settings are transferred easily using a chip card. The machine operator has constant access to all the information about the machine at their workplace, shown on the colour display of the radio remote control.

Protection for the operator and the machine

Telescoping support legs that can be adjusted to any length prove their value, particularly where space is limited. ESC (Ergonic® Setup Control), the safety system from Putzmeister, ensures absolute control, enabling you to work flexibly in accordance with the EN 12001:2012* standard.

* EN 12001:2012: This standard specifies automatic checking of the interplay between the support system, boom movements and the pumping function.

Three defined support positions for the rear swinging support legs
Dimensions from the centre of the chassis: 1.50 m; 2.25 m; 4.05 m (fully flexible)

Four defined support positions for the front telescopic support legs
Dimensions from the centre of the chassis: 1.10 m; 1.85 m; 2.60 m; 3.00 m (Numerous flexible support configurations are possible)



The benefits at a glance

- Light and ergonomic
- High resolution display
- Two symbol styles to choose from: Scribble or technical
- New menu for setting dimming and time
- New Li-ion batteries with charge level display and 8 h capacity
- Plus cable operation
- Backlit buttons
- Shorter start-up time
- Robust electronics
- With a practical waist harness
- Can be conveniently controlled using two joysticks, or just one with EBC
- Feedback system shows working areas, leg positions, machine tilt, etc. and makes it easier for stand-in workers to start working with the machine
- All information available at machine operator's work-place
- Optimised EOC

Technical Data

M42

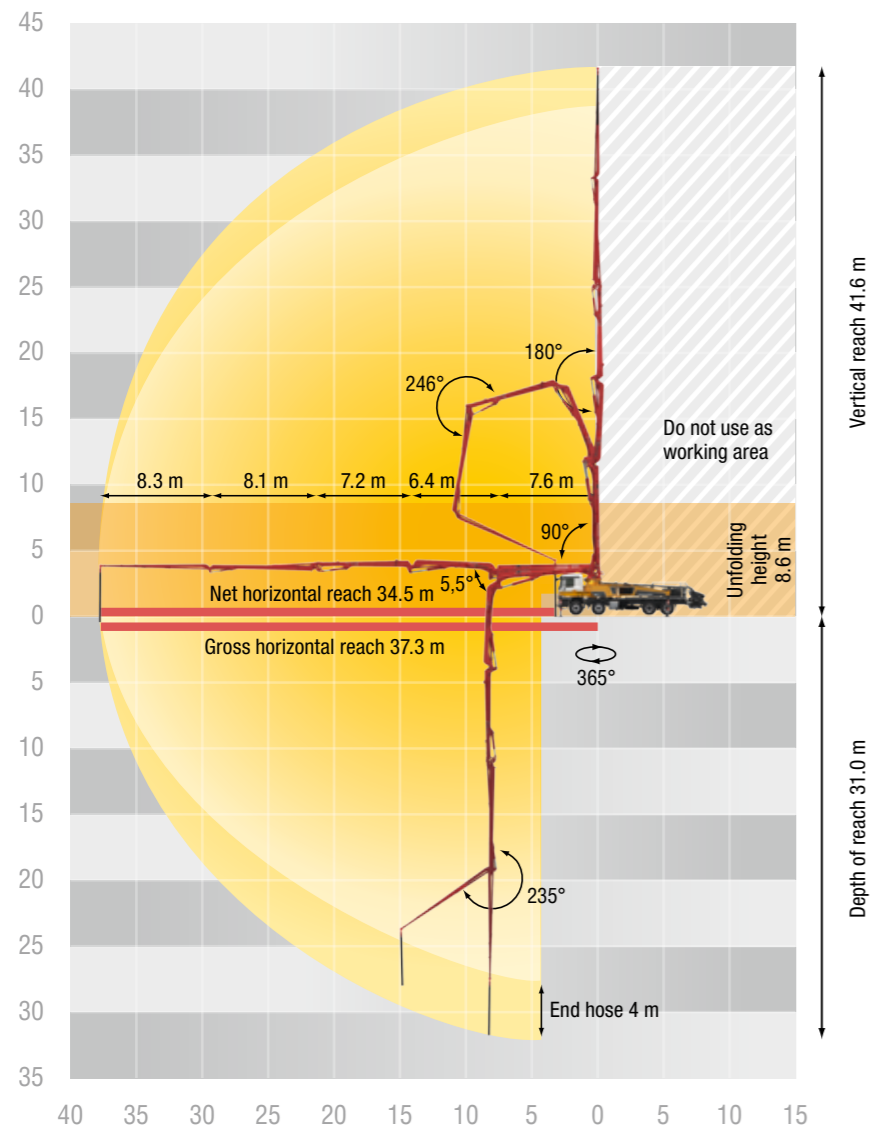

Placing boom

Folding type	5-arm roll Z-folding (RZ)
Vertical reach	41.6 m
Horizontal reach	37.3 m (gross)
Depth of reach	31.0 m
Unfolding height	8.6 m
End hose length	4 m
Delivery lines	DN 125, max. 85 bar
Slewing circle	365°

General

Support width	front / rear
Standard	7.5 m / 7.7 m
ESC	5.0 m / 5.3 m
OSS	5.0 m / 6.1 m
Overall length	11.4 m
Height	under 4,0 m

*Support width based on center of support leg

Equipment lines

To make it easier to select from the numerous configuration options, three comprehensive equipment lines, as well as a few option packages, are available.

Standard line

This equipment includes components which Putzmeister considers to be an economic standard for working efficiently and safely. Combined with the "German/EU road use approval" option package, the machine is ready for use throughout Europe.

High line

The high line provides easier operation, reduced maintenance costs and increased lighting comfort.

Exclusive line

This line represents the highest equipment level offered by Putzmeister. It includes selected premium components.



Standard

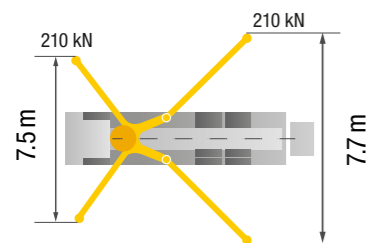

ESC

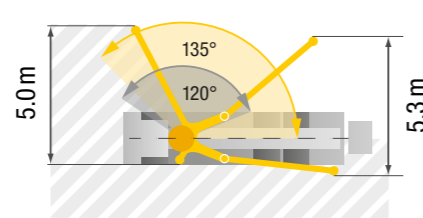

OSS

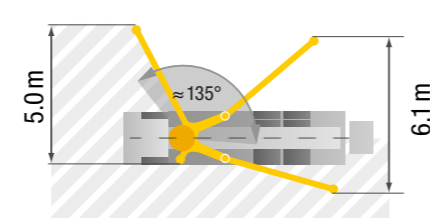

Vertical horizontal

Added value for the same money

In addition to providing greater transparency and easier ordering, the option packages are cheaper than ordering individual options.

- **German/EU road use approval kit** includes all the necessary equipment for approving the machine in the EU
- **Lighting kit** also covers the lighting included in the scope of standard equipment
- **Operating kit 1 – EBC Basis** reduces the vibrations for smoother boom movement
- **Operating kit 2 – EBC Plus** offers a comfort function for boom control
- **Cleaning kit** includes various components which make cleaning the machine easier
- **Camera kit 1 to 3** includes various camera systems, from the reversing camera to the 360° camera
- **Driver kit 1** includes options for increasing the horizontal reach
- **Further individual options** are also available

Build on Putzmeister – in service, parts, training

Everything that sets service apart

Swift assistance, meaningful advice and a reliable supply of genuine Putzmeister accessories and parts - in over 120 countries worldwide. This is what we at Putzmeister understand as first-class service.

Ideally placed to support you

We train our service technicians continuously, provide a close-knit information network and the latest equipment and consistently strive to meet our customers' needs.

Thanks to state-of-the-art technology, our employees have all the relevant technical information about your machine at their fingertips, should the need arise. Allowing us to provide you with the best possible support for emergencies, repairs or preventive maintenance.



Genuine parts for maximum availability

It goes without saying that we use only genuine Putzmeister parts in our workshops. This is the only way to guarantee consistent quality, checked for interoperability. And you can be absolutely sure that your machine meets the tough requirements with maximum performance and availability.

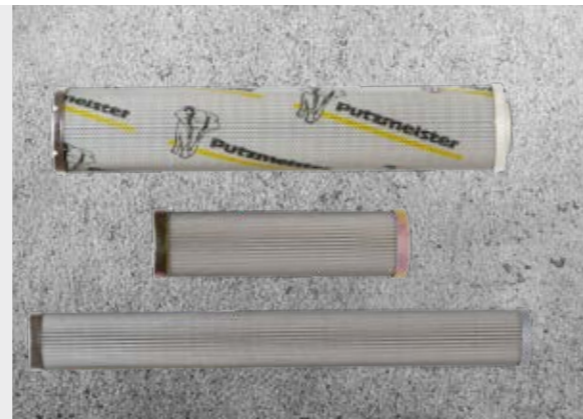

Excellent in quality and customer proximity

In case of need, you have two options: Either the service team visits you or you take your machine to one of our service workshops. The latest tools, software analysis solutions and genuine parts ensure that your machine is operable again immediately.

All Putzmeister workshops and the workshops of our international Putzmeister partners meet our high-quality standard. Especially when it comes to manufacturer's inspections and acceptance procedures in accordance with specifications.



Induction at handover – everything correct from the outset

So you and your machinist can adapt perfectly to all special features and innovations.

Customer training – benefit from expert knowledge

Practice-oriented learning offers many benefits: Your staff master the machine with all its special features, use the machine to optimum effect, reduce operating costs and avoid operating errors.

Our services for cost-effective work

The Putzmeister service support points offer you these services - all provided by our experienced service staff:

100 hours of customer service – avoid potential sources of error

With this customer service you receive a status report on your concrete pump as per the Putzmeister service plan.

Mandatory machine inspection – calculable costs instead of incalculable failures

Visual inspection and functional check of components for 100 % safety. The hydraulic system with cylinders, electrical system and core pump are also inspected.

500 hours of customer service – protect your investment, retain your value

Our technical customer service team is the number one choice for checking the safety and wear of your machine. You receive a status report for this, too.

Our range of training courses and seminars:

For concrete pump operators

- Training and development seminars on concrete pumps
- Training and development seminars on PUMI with piston and rotor pumps
- Regional/company seminars (in your region or on your premises)

For concrete pump mechanics

- Training and development seminars on concrete pump

For concrete pump machinists and mechanics

- Practical days in Aichtal
- Training: Handover and induction, on-the-job training

For workshop managers and foremen

- Overview of current developments in Putzmeister concrete pumps
- Qualification at the customer workshops for requisite maintenance work

Further information can be found at: www.pm-akademie.de



The M42 at a glance

- A gross weight of less than 32 t incl. sufficient reserves for payload and operating materials
- Smooth 5-arm placing boom thanks to intelligent laying of the delivery line and the balanced development of the steel structure
- Efficient work through consistently clever ergonomic design
- Even better safety through closer consideration for current standards and guidelines
- Service-friendly as a result of its optimised accessibility and consistent bolted concept
- Lower service costs thanks to maintenance-free components, fewer different components (e.g. only 3 standard delivery line bends) and lower volumes of operating materials (oil volume reduced by 30%)



Note: The diagrams in the brochure do not necessarily correspond to the full scope of standard equipment for the machines.
Further brochures: Ergonic® 4691



Putzmeister Concrete Pumps GmbH

Max-Eyth-Straße 10 · 72631 Aichtal / Germany
P.O.Box 2152 · 72629 Aichtal / Germany
Tel. +49 (7127) 599-0 · Fax +49 (7127) 599-520
pmw@putzmeister.com · www.putzmeister.com

